

Technical data sheet

1032-002C / SKHZZ 3 - 6

(Status as of 15/01/2024)

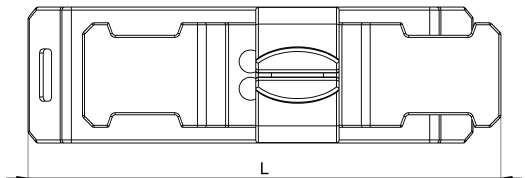
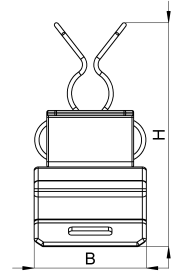
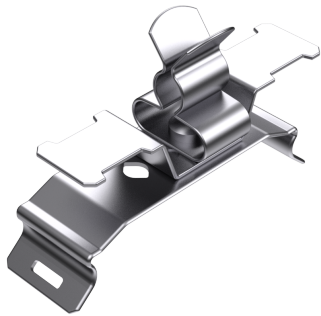

Design features

Dimensions (L / B / H) (mm)	44.5 x 13.1 x 25.8
Shield diameter min/max (mm)	3 / 6
Strain relief	Yes
Weight (kg)	0,008
Part	Shield clamp
Part 2	clip foot
Material	galvanized spring steel
Material 2	galvanized spring steel
Mounting type	DIN rail

Order designation

Designation	Order No.	Description	PU
SKHZZ 3 - 6	1032-002C	Shield clamp with double-sided strain relief, staggered on clip foot, for mounting on 35mm DIN rails, shield diameter 3 - 6mm	PU = 10 pcs.